

INSTALLATION INSTRUCTIONS

77-2550
Ford

2004 F-150 Heritage
1997-03 F-150
V6-4.2L

NOTE: This kit was not designed to fit vehicles with a body lift.

TOOLS NEEDED:

Flat blade screwdriver
5mm allen wrench
Ratchet
10mm Socket
9/16" Socket
9/16" Wrench

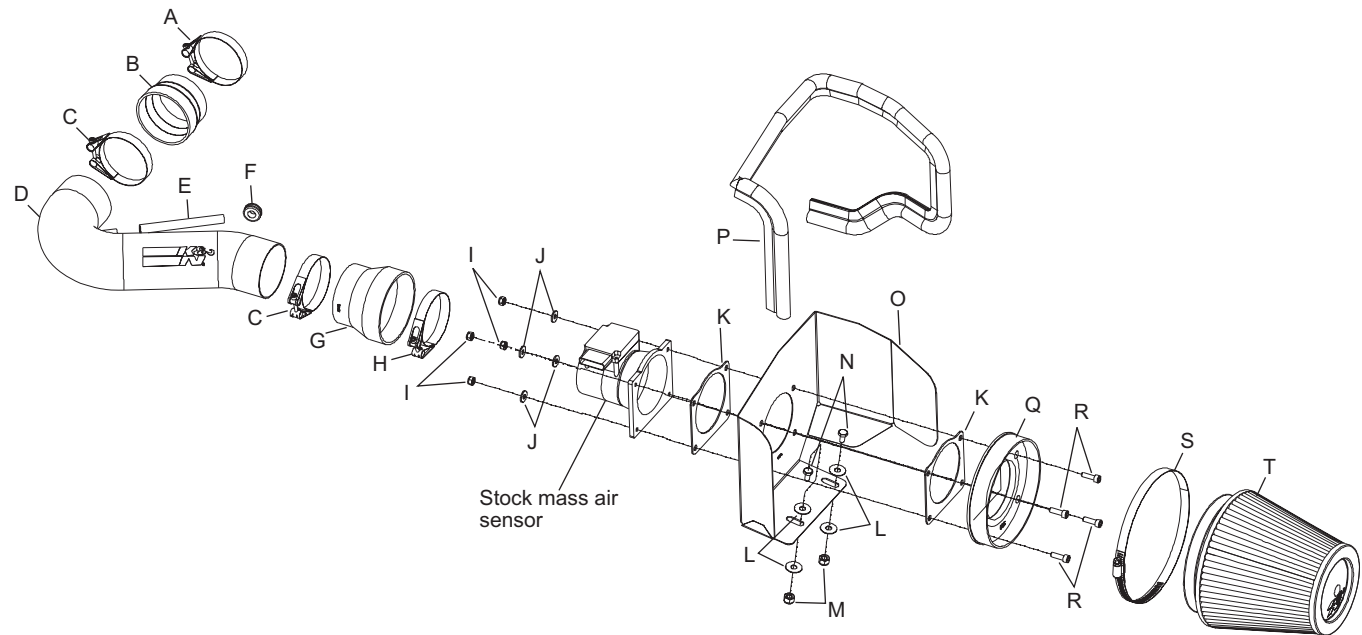

PARTS LIST:

Description	Qty.	Part #	Description	Qty.	Part #	Description	Qty.	Part #
A Hose Clamp, #40	1	08554	F Grommet, 7/16" ID	1	08092	K Gasket, 1/16" Neoprene	2	09330
B Silicone Step Hose, Black	1	08096	G Hose, 3" ID to 3-1/4" ID Step,	1	08429	L Washer, 3/8" Flat	4	08134
C Hose Clamp, #44	2	08560	H Hose Clamp, #52	1	08610	M Nut, 3/8-16 Nylock	2	08255
D Intake Tube	1	27133	I Nut, 6mm Nylock	4	07512	N Bolt, 3/8-16 x 1-1/14"L, Hex	2	07779
E Hose, 8mm 4-1/2" L.	1	08074	J Washer, 6mm Flat	4	08269	O Heat Shield, FB/PC	1	07315
						P Edge Trim, 3/4" Bulb, 39"L	1	102496
						Q Adapter, Mass Air	1	08831
						R Bolt, M6-1.00x25mm L,	4	07862
						S Hose, Clamp, #104	1	08697
						T Air Filter, 6" Flange	1	RC-5107

NOTE: FAILURE TO FOLLOW INSTALLATION INSTRUCTIONS AND NOT USING THE PROVIDED HARDWARE MAY DAMAGE THE INTAKE TUBE, THROTTLE BODY AND ENGINE.

TO START:

1. Turn off the ignition and disconnect the negative battery cable.

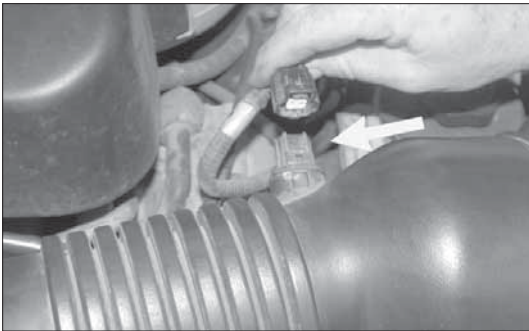

2. Disconnect the air temperature sensor electrical connection as shown.

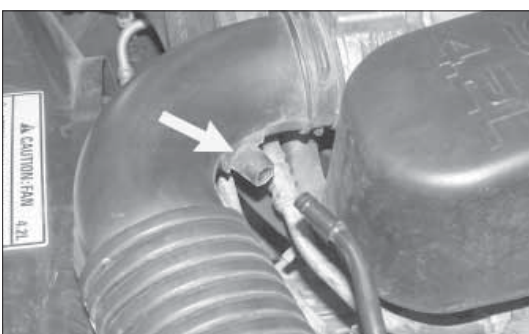

3. Disconnect the crank case vent hose from the stock intake.

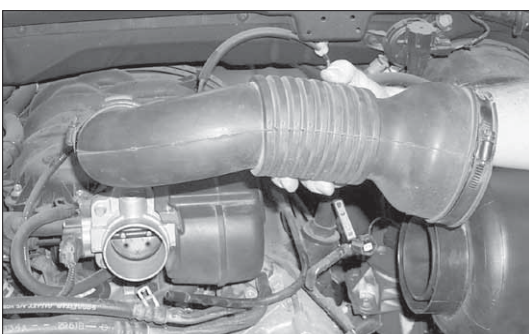

4. Loosen the hose clamps at the throttle body and at the air cleaner, then, remove the stock intake tube as shown.



5. Pull up on the air cleaner assembly to release it from the stock grommets.

NOTE: K&N Engineering, Inc., recommends that customers do not discard factory air intake.

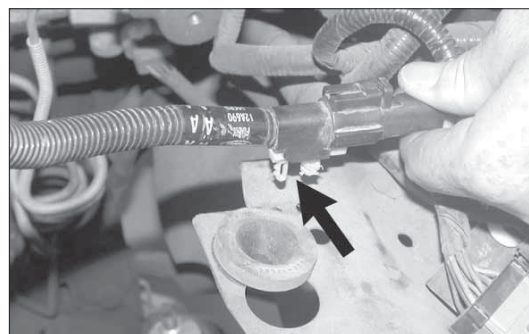

6. Remove the mass air wire harness from the air cleaner support bracket, which is located below the air cleaner assembly.



7. Disconnect the secondary mass air sensor electrical connection as shown.

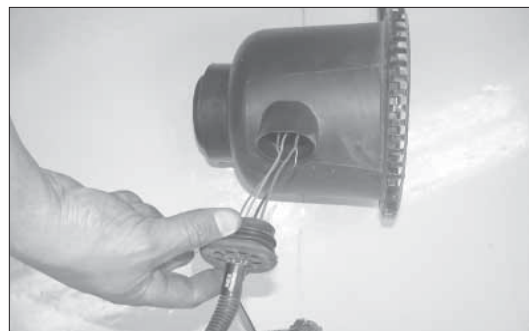

8. Disassemble the air cleaner assembly, then, pull the plastic wire cover, and the rubber boot back on the mass air electrical connection as shown.

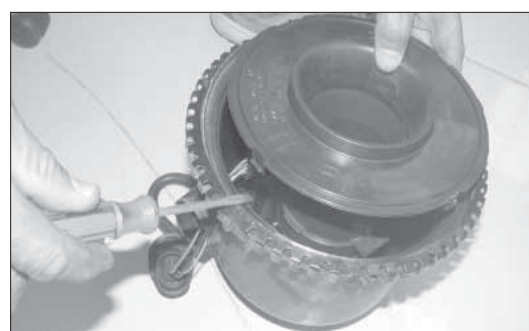

9. Using a flat blade screwdriver release the housing cover by depressing the four release clips as shown.

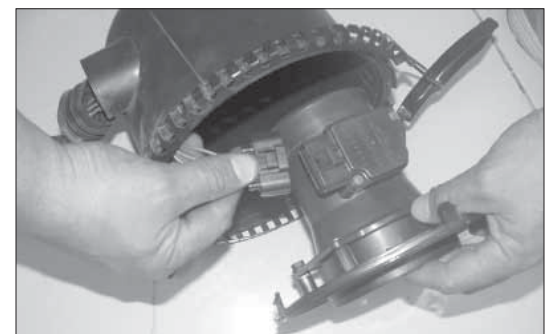

10. Pull the mass air sensor out of the housing and disconnect the mass air sensor electrical connection as shown.



11. Remove the mass air sensor from the housing cover which is secured by two bolts.



12. Install the provided edge trim onto the provided heat shield and trim to fit if necessary.



13. Assemble the provided mass air adapter, gaskets, heat shield and the stock mass air sensor using the provided hardware as shown.



14. Secure the heat shield assembly to the stock air cleaner mounting grommets using the provided hardware as shown.

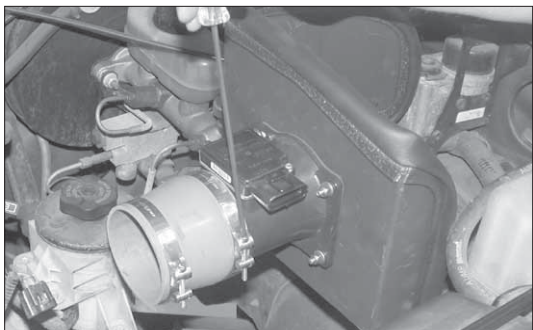

15. Install the silicone step hose and hose clamps onto the mass air sensor and tighten as shown.

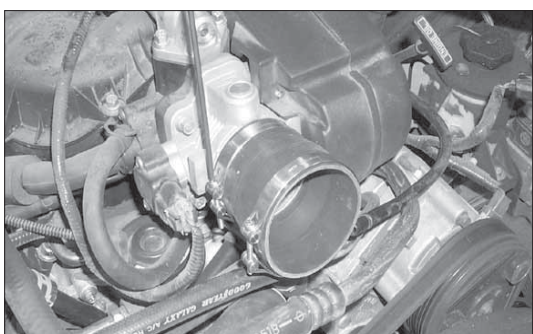

16. Install the silicone hose and hose clamps onto the throttle body and tighten as shown.

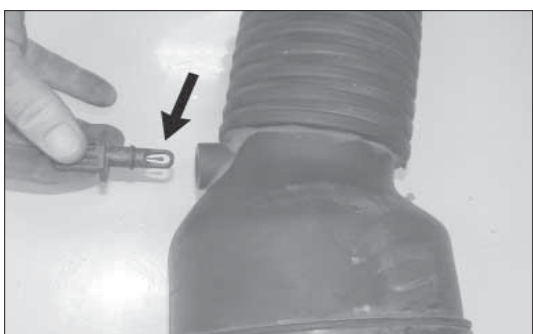

17. Remove the air temperature sensor from the stock intake tube as shown.

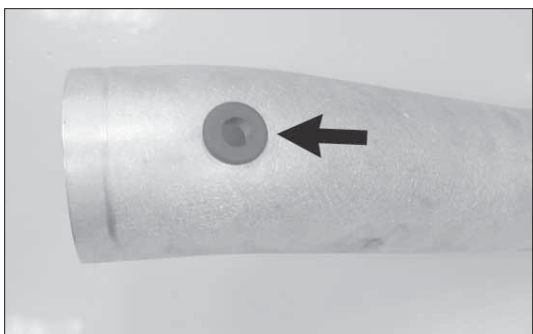

18. Insert the provided rubber grommet into the K&N intake tube as shown.

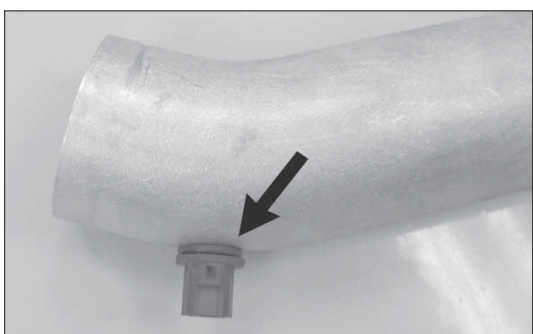

19. Install the air temperature sensor from step 17 into the grommet on the K&N intake tube as shown.

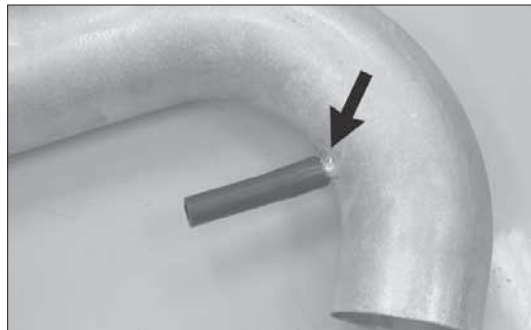

20. Install the provided silicone hose onto the vent on the K&N intake tube as shown.

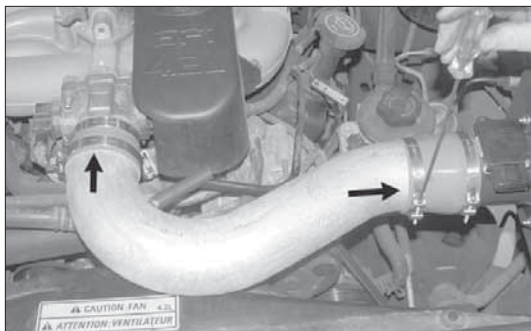

21. Slide the tube into the silicone hose on the mass air sensor, then, slide the other end into the silicone hose on the throttle body, adjust everything for best fit and clearance, then, tighten all hose clamps and hardware as shown.

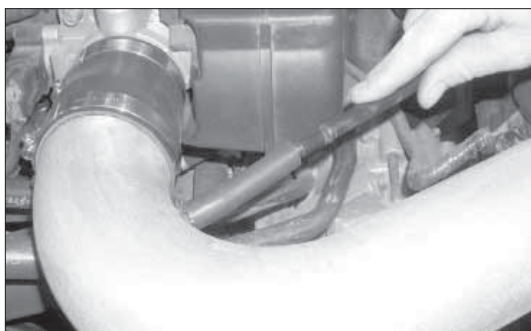

22. Reconnect the crank case vent hard line to the silicone hose on the K&N intake tube as shown. Trim to fit if necessary.

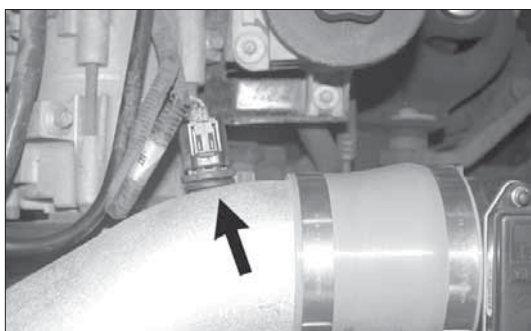

23. Reconnect the air temperature sensor electrical connection as shown.

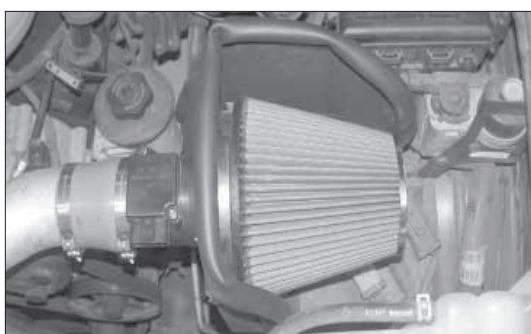

24. Install the K&N air filter and secure with the provided hose clamp as shown.

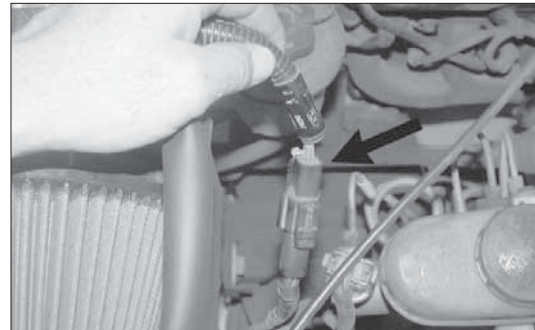

25. Reconnect the secondary mass air electrical connection as shown.

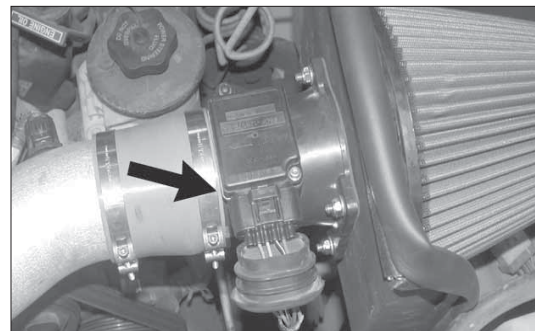

26. Reconnect the primary mass air sensor electrical connection as shown.

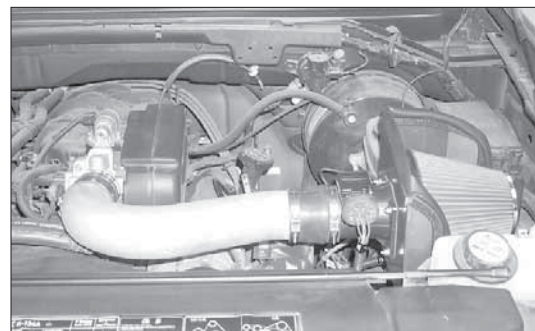

27. Reconnect the vehicle's negative battery cable. Double check to make sure everything is tight and properly positioned before starting the vehicle.

28. The C.A.R.B. exemption sticker, (attached), must be visible under the hood so that an emissions inspector can see it when the vehicle is required to be tested for emissions. California requires testing every two years, other states may vary.

29. It will be necessary for all K&N high flow intake systems to be checked periodically for realignment, clearance and tightening of all connections. Failure to follow the above instructions or proper maintenance may void warranty.

ROAD TESTING:

1. Start the engine with the transmission in neutral or park, and the parking brake engaged. Listen for air leaks or odd noises. For air leaks secure hoses and connections. For odd noises, find cause and repair before proceeding. This kit will function identically to the factory system except for being louder and much more responsive.

2. Test drive the vehicle. Listen for odd noises or rattles and fix as necessary.

3. If road test is fine, you can now enjoy the added power and performance from your kit.

4. K&N Engineering, Inc., suggests checking the air filter element periodically for excessive dirt build-up. When the element becomes covered in dirt (or once a year), service it according to the instructions on the Recharger service kit, part number 99-5050 or 99-5000.

50-STATE STREET LEGAL
K&N CARB EXEMPT
K&N

* FREE K&N decal To register your warranty, please see us online at knfilters.com/register. FREE K&N decal *

• 1455 CITRUS ST., P.O. BOX 1329, RIVERSIDE, CA., U.S.A. 92502 • TECH SERVICE 800-858-3333 • FAX 951-826-4001
 • e-mail: tech@knfilters.com • WWW: <http://www.knfilters.com>

170026k
 3/8/10